

Electric pump

EL606SA/B

PUMP SPECIFICATIONS	Mod. A	Mod. B
Capacity [m ³ /h - (USGPM)]	240 - (1056)	420 - (1850)
Head [m - (ft)]	38 - (124)	30 - (98)
Impeller diameter [mm - (in)]/type	440 - (17.6)/3 blades closed	
Flanged bore size [DN.../PN... - (in)]	DN150/PN10 - (6)	DN200/PN10 - (8)
Cross section diameter [mm - (in)]	60 - (2.4)	
Weight (without cable) [kg - (lbs)]	1200 - (2640)	1250 - (2750)

ELECTRIC MOTOR	
Power [kW-HP]	90-120
Voltage [V]/Current [A]	460/149
Phases/Poles/Frequency [Hz]	3/6/60
Speed [RPM]	1180
Insulation class	H
Power cable 20m (IEC 60245- 4)	H07RN-F 4G35

MATERIALS	
Casing	Spheroidal cast iron EN-GJS-500-7 (EN 1563)
Motor housing	Cast iron EN-GJL-250 (EN 1561)
Wear parts	High chrome EN-GJN-HV600 (XCr18) (EN 12513)
Main shaft	High tensile steel 39NiCrMo3 (AISI 9840)

SEALS / LUBRICANT	
Motor side seals	2 lip seals (BUNA)
Impeller side seals	5 lip seals (3 BUNA + 2 PTFE) + 1 V-RING (TPU)
Oil type	ISO 320

DIMENSIONS [mm - (in)]							
H	W	D	F	H1	A	B	C
1610	935	725	545	1055	365	430	325
(64.4)	(37.4)	(29)	(21.8)	(42.2)	(14.6)	(17.2)	(13)

PERFORMANCE CURVES

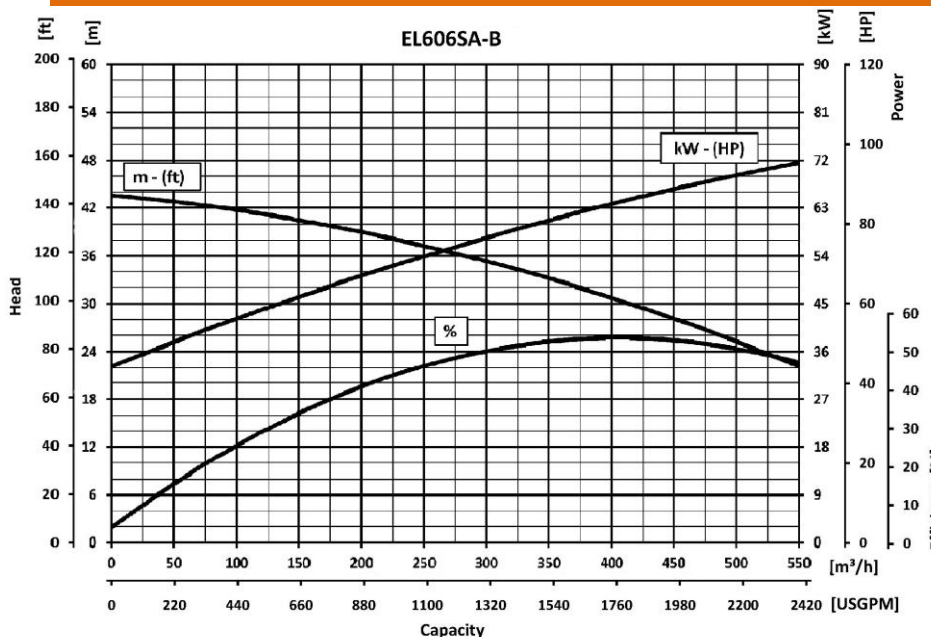

We reserve the right to make changes without notice

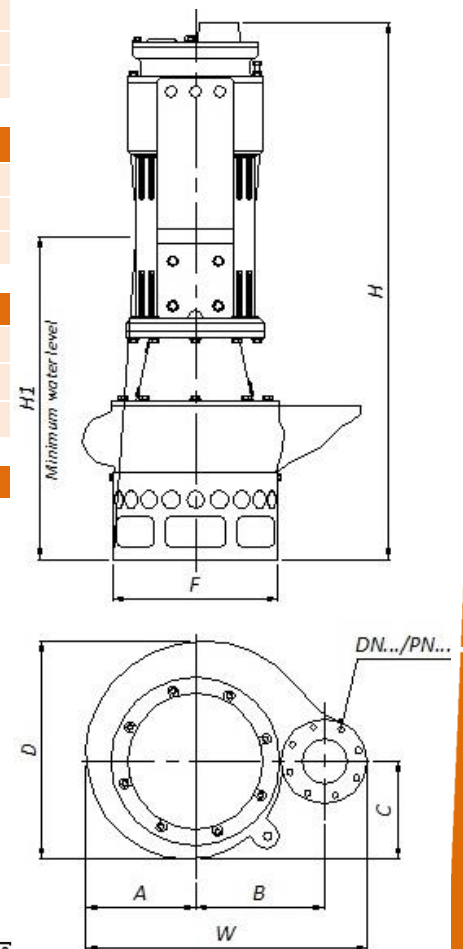

EL606SA-B

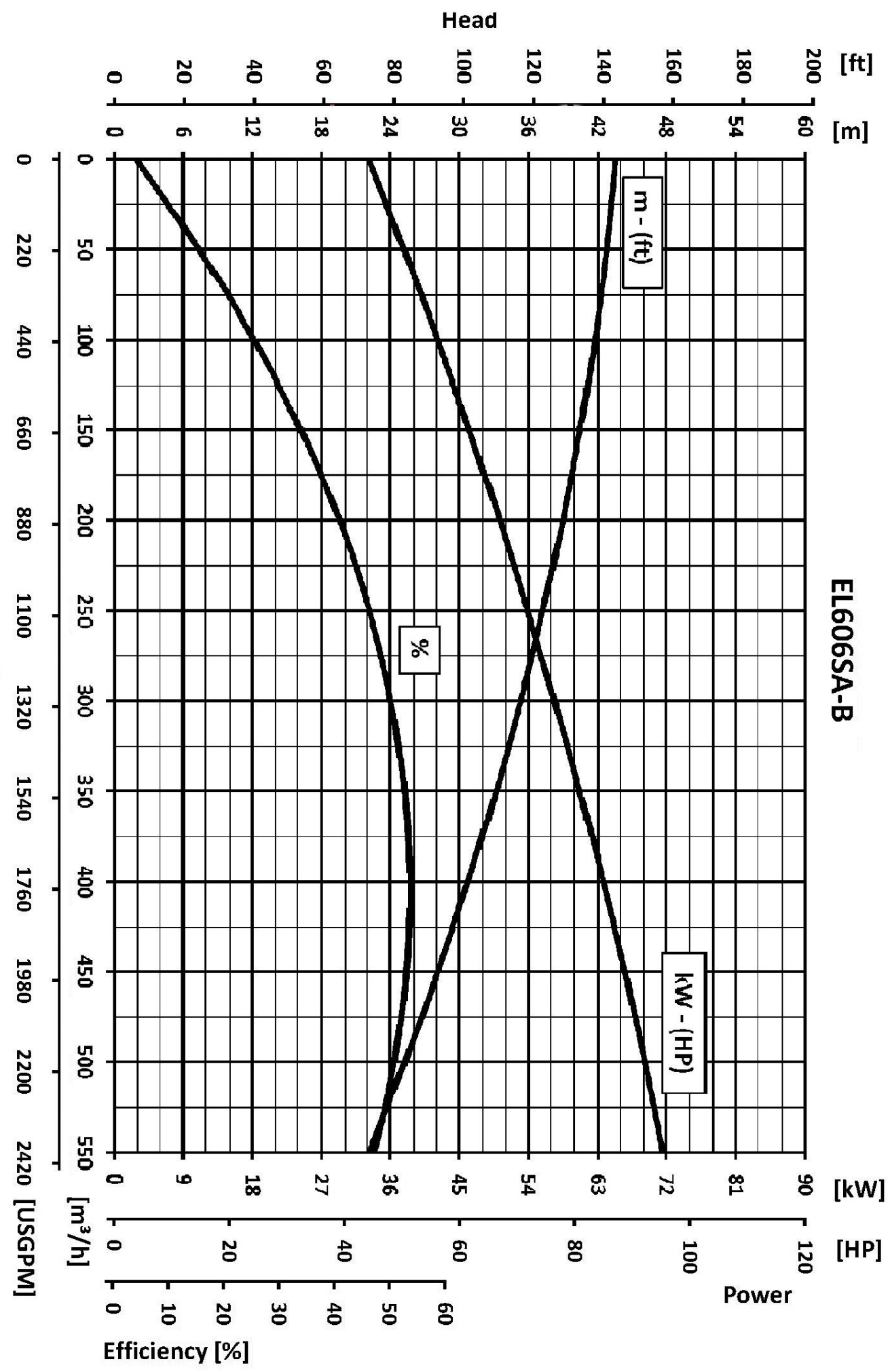

We reserve the right to make changes without notice